

KBL12750 12V 75Ah



Kaise Battery series are Top terminal VRLA AGM battery for General use. With advanced manufacturing technique and industry scale, KBL series delivers high energy density and high reliability performance, highly suited for UPS systems, security and alarm systems, telecommunication, utilities, emergency light systems, CATV and other backup applications.



Technical Specifications

Nominal Voltage (V)	12 (6 cells per unit)
Designed Floating Life (25°C)	12 Years
Nominal Capacity (25°C)	75 Ah @ 10HR-rate (to 1.80Vpc)
Dimension (mm)	L266 x W168 x H208 x TH213
Approx. Weight	22.5 kg (49.6 lbs)
Terminal Type	Female Copper Insert M6 (torque: 6~8Nm)
Internal Resistance	Approx. 0.0062 Ohm (fully charged @ 20°C)
Max. Charge Current	18A
Max. Discharge Current (5S)	675A
Short Circuit Current	1900A
Self Discharge	Approx. 3% per month @ 25°C
Ambient Temperature	Discharge: -20~55°C Charge: -20~50°C Storage: -20~45°C
Float Charge Voltage	13.6V/block @25°C (-3mV/cell/ C)
Equalize and cycle Use Charge Voltage	14.4V/block @25°C
Container Material	ABS (UL94-V0 optional)



Complied standards

- IEC 60896-21/22
- GB/T19638
- JIS C8704
- BS6290 part 4

Battery Dimensions

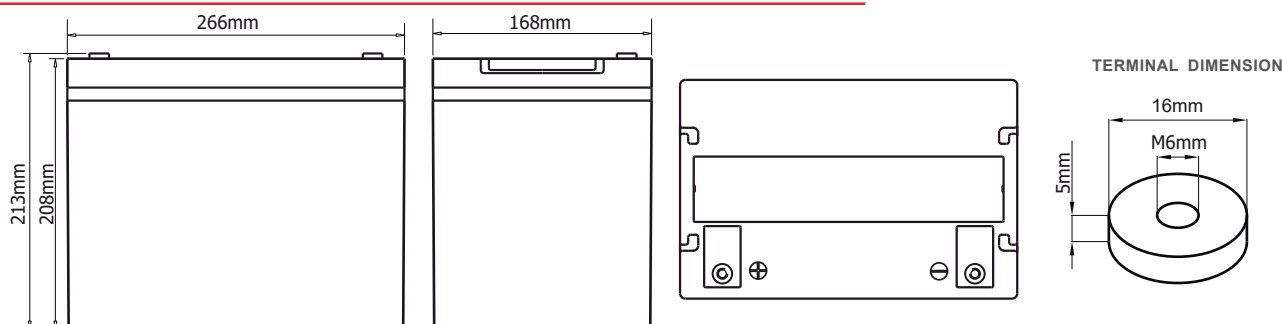

Constant Current Discharge Characteristics: Amps (25°C)

F.V/Time	5min	10min	15min	30min	1h	3h	4h	5h	10h	20h
1.60 V	225	116	137	84.5	50.7	21.3	16.9	14.1	7.95	4.28
1.67 V	201	153	129	80.7	49.4	21.0	16.7	13.9	7.85	4.19
1.70 V	179	139	122	77.7	48.2	20.8	16.6	13.8	7.76	4.09
1.75 V	156	129	113	75.0	47.2	20.4	16.4	13.6	7.65	4.01
1.80 V	138	117	106	71.7	45.7	20.0	16.0	13.3	7.50	3.95
1.85 V	118	106	96.3	67.7	43.7	19.4	15.5	13.0	7.31	3.84

Constant Power Discharge Characteristics: W/Cell (25°C)

F.V/Time	5min	10min	15min	30min	1h	3h	4h	5h	10h	20h
1.60 V	396	298	250	156	94.5	40.1	32.1	26.9	15.4	8.31
1.67 V	358	278	237	150	92.6	39.9	31.9	26.7	15.3	8.18
1.70 V	323	255	226	145	91.0	39.7	31.8	26.6	15.2	8.06
1.75 V	285	240	212	142	89.9	39.4	31.7	26.5	15.1	7.95
1.80 V	255	220	200	137	87.7	39.0	31.3	26.1	14.9	7.86
1.85 V	222	201	184	130	84.8	38.1	30.6	25.7	14.6	7.73

Charge Characteristic

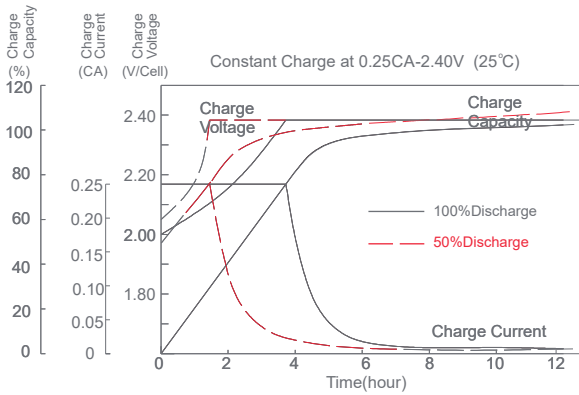

Discharge Characteristic (25°C)

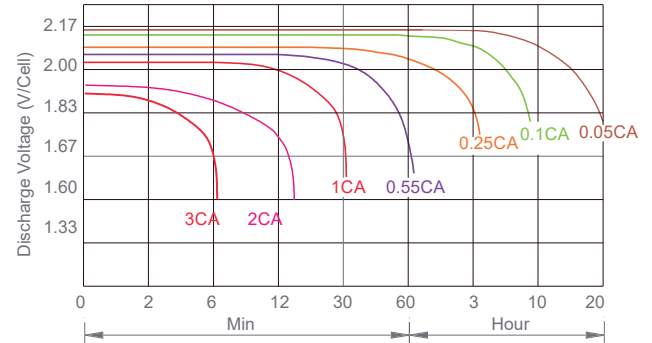

Temperature vs Float Life

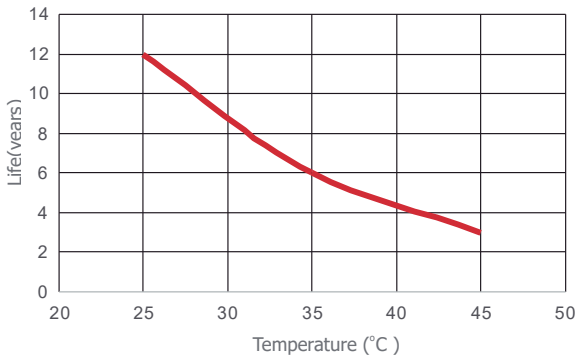

Self discharge characteristics

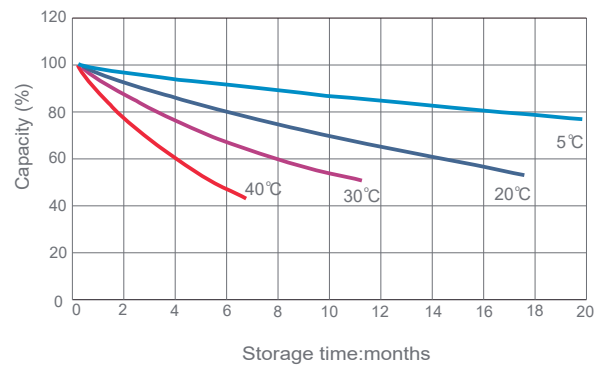

Float voltage vs Float life

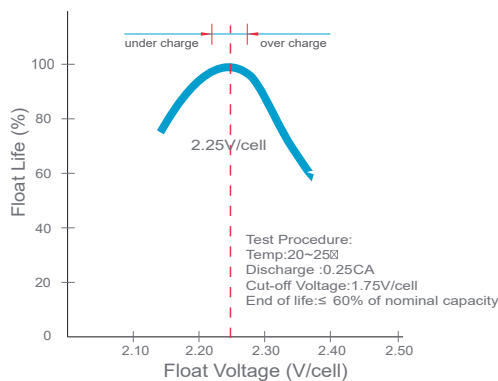

Capacity vs Temperature

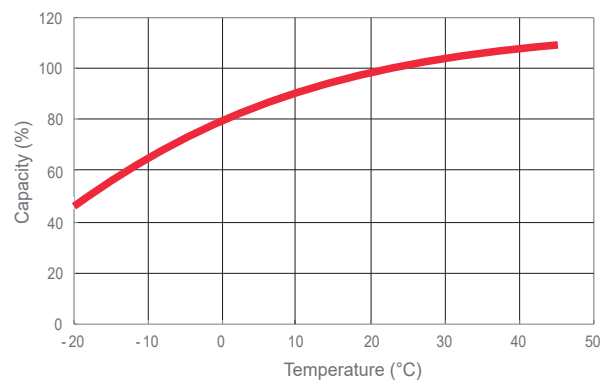

Final voltage settings recommended according to the discharge current

Discharge Current I (A)	$I \leq 0.08C$	$0.08C \leq I < 0.2C$	$0.2C \leq I < 0.6C$	$0.6C \leq I < 1.0C$	$I \geq 1.0C$
Final of Voltage	$\geq 1.85V_{pc}$	$\geq 1.80V_{pc}$	$\geq 1.75V_{pc}$	$\geq 1.70V_{pc}$	$\geq 1.60V_{pc}$